

**FOR  
FRONT LEFT**

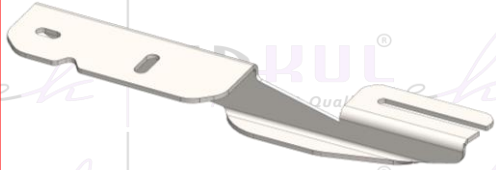

**A (x2)**

**FOR  
REAR LEFT**



**B (x2)**



**ERKUL**<sup>®</sup>  
Products & Quality



# VOLVO XC-40 2018 → RUNNING BOARD



A+C+D

B+C+E

**C (x4)**

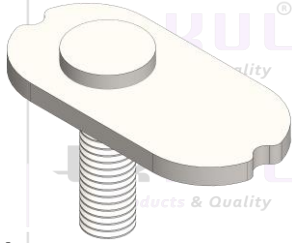

**D (x2)**

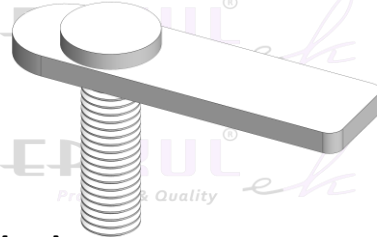

**E (x2)**



**M10 (x6)**

**M6 (x2)**

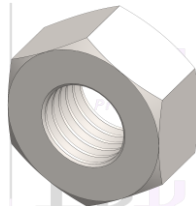

**M10 (x6)**

**M6 (x2)**

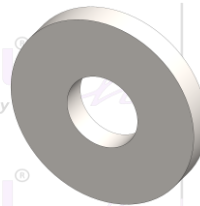

**M8 (x8)**

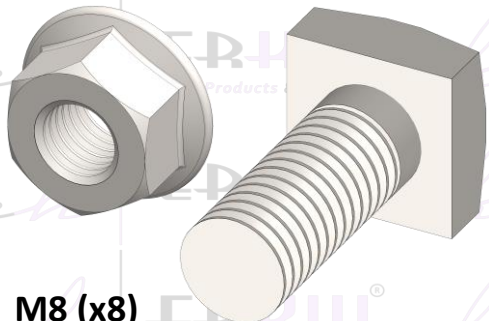

# instructions



# FRONT BRACKET

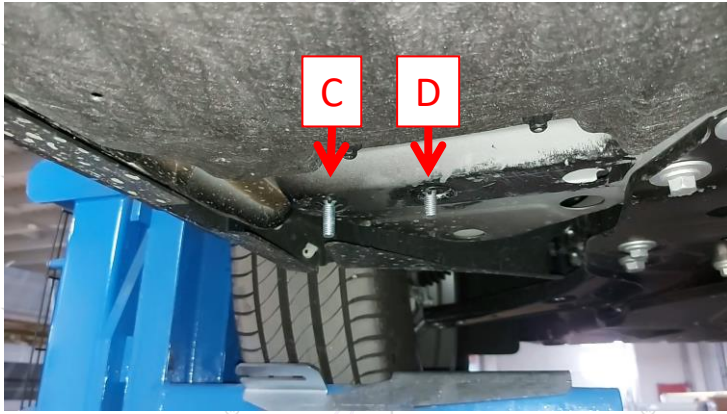

# REAR BRACKET

